

Article number: 439500200

Description: Rota-fix shaft-hub connection F200x260
Steel

Note: Self centering. Very high torque

Measures

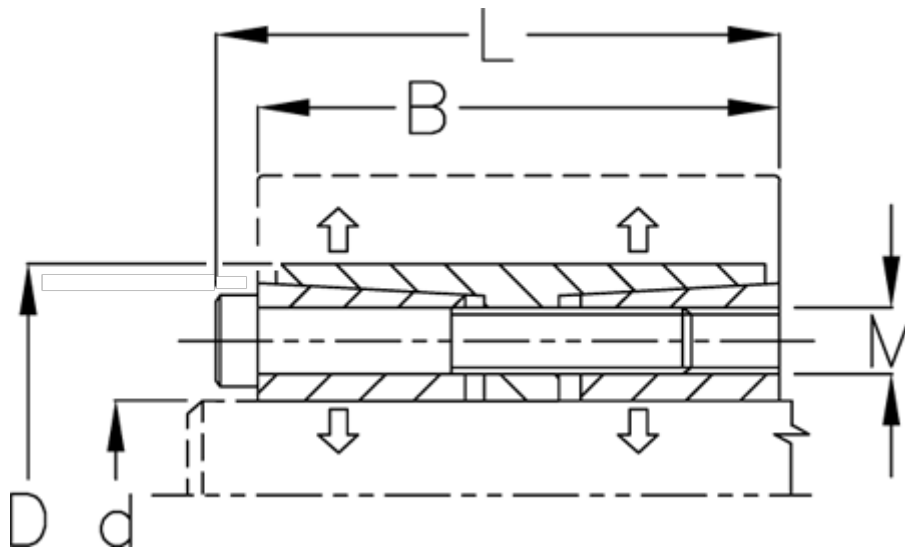

B mm	= 146
d H8 mm	= 200
D mm	= 260
Fit tolerance	= Aksel h8, Nav H8
F kN torque	= 1200.0
L mm	= 162
M mm	= M16
P N/mm ² surface pressure on shaft/hub	= 100

Surface roughness	= R? ? 3.2 µm
T N m torque	= 128000
Ts N m bolt tightening torque	= 355.0